



PETTITI GIUSEPPE s.p.a.

SERIE MAGNUM

PORTATA CAPACITY PORTEE	Per coppia di carrelli For each pair of trolleys Pour couple de chariots
Kg 1000	a 4 cuscinetti with 4 bearings a 4 coussinets

CARRELLI ED ACCESSORI PER MONOROTAIA G8E

TROLLEYS AND ACCESSORIES FOR RAIL G8E

CHARIOTS ET ACCESSOIRES POUR MONORAIL G8

MONOROTAIA IN ACCIAIO ZINCATO, CON ASOLE

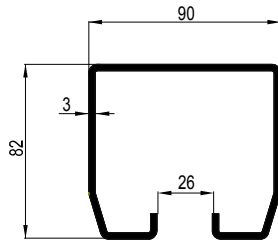

Lunghezza = 6 m
Length = 6 m
Longueur = 6 m

Rail in zinked steel.

Monorail en acier zingue.

ART.	Confz. Box	Peso Kg Weight	
G8E	36 m n° 6x6 m	Kg/m 7,000	

CARRELLO CENTRALE A 4 RUOTE

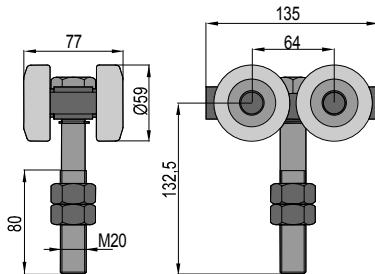

4RMAE

Fisso - cuscinetti in acciaio
Fix - steel bearings
Fixe - coussinets en acier

Central trolley with 4 wheels.

Chariot coulissant à 4 roulements.

ART.	Confz. Box	Peso Kg Weight	
4RMAE	6	2,400	

PIASTRA FISSA CON OLIVA GIREVOLE IN OTTONE

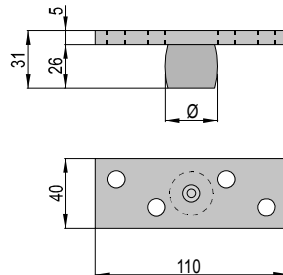
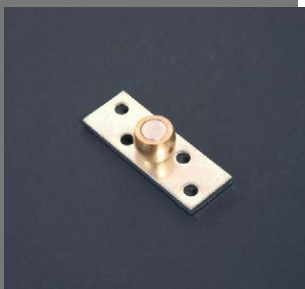

Fix plate with rotating brass olive.

Platine fixe avec olive pivotante en laiton.

ART.	Ø	Confz. Box	Peso Kg Weight	
309/25	25	25	0,270	
309/30	30	25	0,310	

FERMO DI ARRESTO CON PARACOLPO IN GOMMA

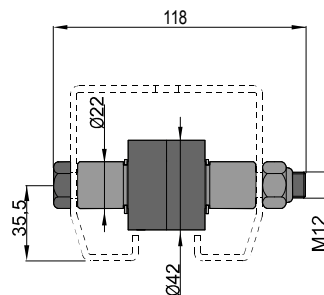

Back stop with rubber buffer.

Ferme d'arrêt avec butoir en gomme .

ART.	Confz. Box	Peso Kg Weight	
4100E	6	0,350	

GUIDA INFERIORE IN ACCIAIO ZINCATO

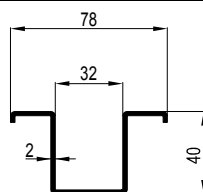

Lunghezza = 6 m
Length = 6 m
Longueur = 6 m

Lower guide in zinked steel.

Guide inferieure en acier zingue.

ART.	Confz. Box	Peso Kg Weight	
G8I	36 m n° 6x6 m	Kg/m 2,730	

ATTACCO LATERALE REGISTRABILE

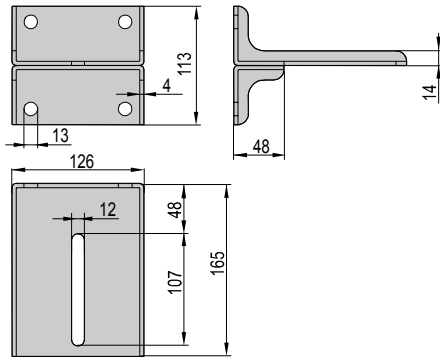

Adjustable support for rail G8E.
Bride pour rail G8E avec réglage.

ART.	Confez. Box	Peso Kg Weight	
ALG8	4	1,300	

Esempio di applicazione con scorrimento lineare.
L'applicazione è valida per le serie Magnum, Sempione e Frejus.

Application example with linear sliding.
The application is valid for Magnum, Sempione and Frejus series.

Exemple d'application avec roulement linéaire.
L'application est valide pour les séries Magnum, Sempione et Frejus.

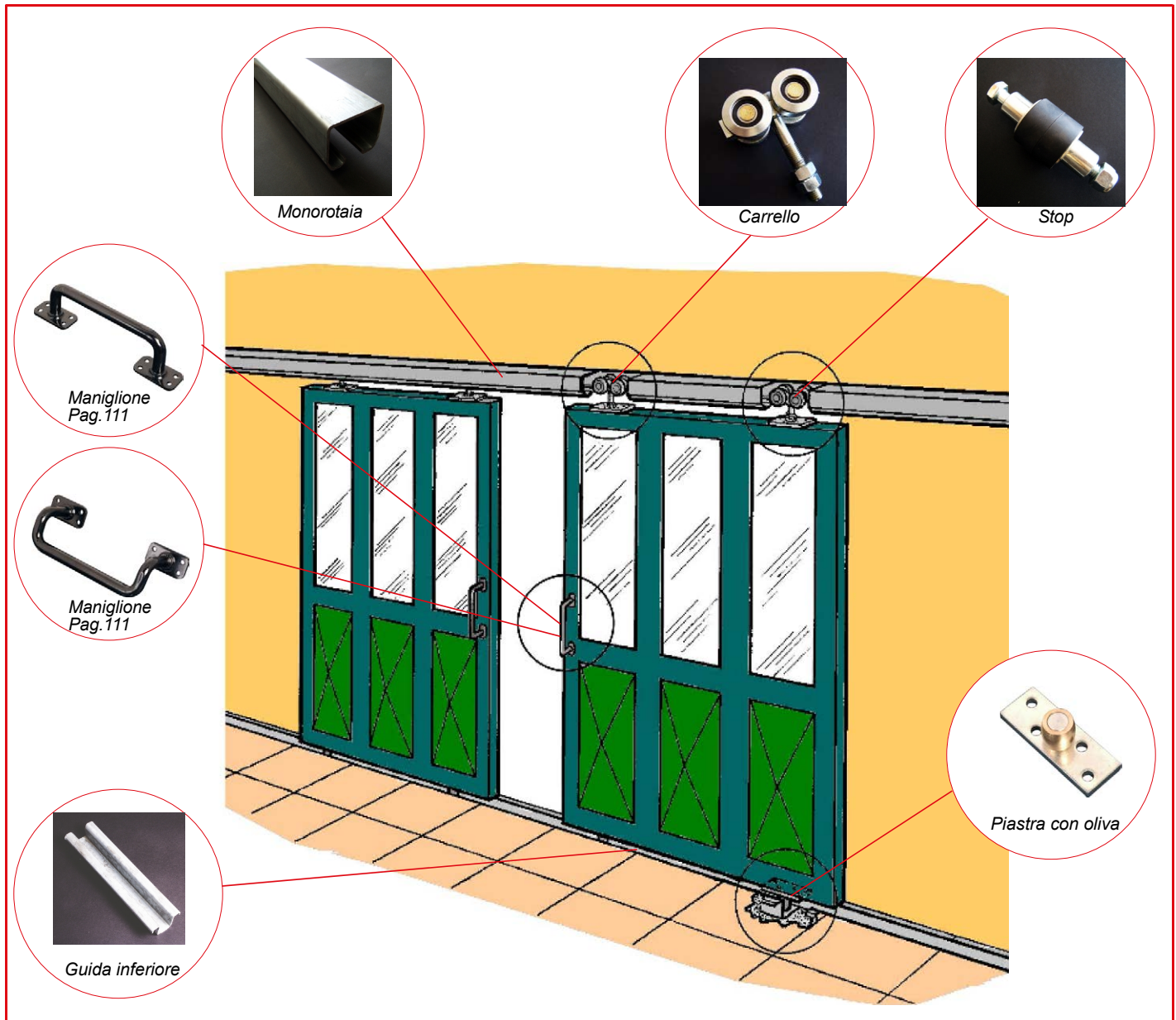



PETTITI GIUSEPPE s.p.a.

SERIE SEMPIONE

PORTATA CAPACITY PORTEE	Per coppia di carrelli For each pair of trolleys Pour couple de chariots
Kg 400	a 2 cuscinetti with 2 bearings a 2 coussinets
Kg 750	a 4 cuscinetti with 4 bearings a 4 coussinets

CARRELLI ED ACCESSORI PER MONOROTAIA G9Z

TROLLEYS AND ACCESSORIES FOR RAIL G9Z

CHARIOTS ET ACCESSOIRES POUR MONORAIL G9Z

MONOROTAIA IN ACCIAIO ZINCATO

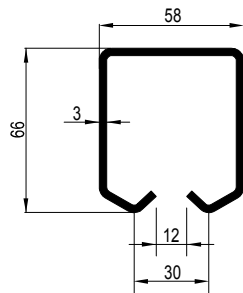

Lunghezza = 6 m
Length = 6 m
Longueur = 6 m

Zinked steel rail.
Monorail en acier zingue .

ART.	Confez. Box	Peso Kg Weight
G9Z	36 m n° 6x6 m	Kg/m 4,980

CARRELLO FISSO A 2 RUOTE

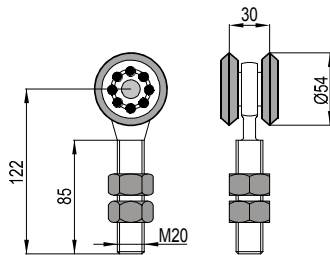

Fix trolley with 2 wheels.
Chariot fixe a 2 roulements.

2RG	Fisso - cuscinetti cementati Fix - cemented bearings Fixe - coussinets cements
2RG/C	Fisso - cuscinetti zincati Fix - zinked bearings Fixe - coussinets zingue

ART.	Confez. Box	Peso Kg Weight
2RG	8	0,750
2RG/C	8	0,750

CARRELLO FISSO A 4 RUOTE

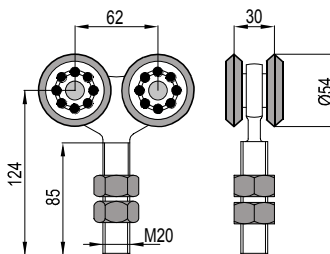

Fix trolley with 4 wheels .
Chariot fixe à 4 roulements.

4RG	Fisso - cuscinetti cementati Fix - cemented bearings Fixe - coussinets cements
4RG/C	Fisso - cuscinetti zincati Fix - zinked bearings Fixe - coussinets zingue

ART.	Confez. Box	Peso Kg Weight
4RG	4	1,250
4RG/C	4	1,250

CARRELLO FISSO A 2 RUOTE CON CUSCINETTI

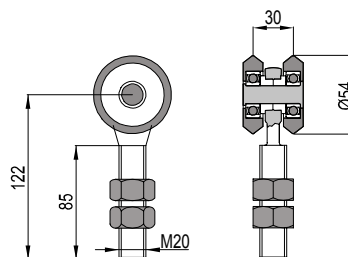

Fix trolley with 2 wheels with bearings .
Chariot fixe à 2 roulements avec coussinets.

2RG/CU	Fisso - con cuscinetti Fix - with bearings Fixe - avec des coussinets
---------------	---

ART.	Confez. Box	Peso Kg Weight
2RG/CU	8	0,750

CARRELLO FISSO A 4 RUOTE CON CUSCINETTI

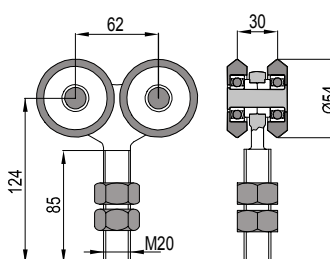

Fix trolley with 4 wheels with bearings .
Chariot fixe à 4 roulements avec coussinets.

4RG/CU	Fisso - con cuscinetti Fix - with bearings Fixe - avec des coussinets
---------------	---

ART.	Confez. Box	Peso Kg Weight
4RG/CU	4	1,250

CARRELLO GIREVOLE A 2 RUOTE

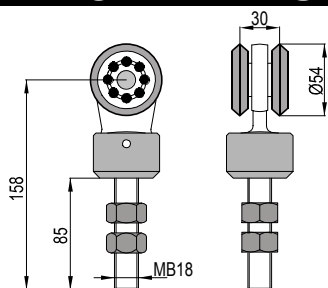

Rotating trolley with 2 wheels .
Chariot pivotant à 2 roulements.

2RGS

Girevole - con cuscinetti cementati
Slewing - with cemented bearings
Pivotant - coussinets cements

ART.	Confez. Box	Peso Kg Weight
2RGS	6	1,250

CARRELLO GIREVOLE A 4 RUOTE

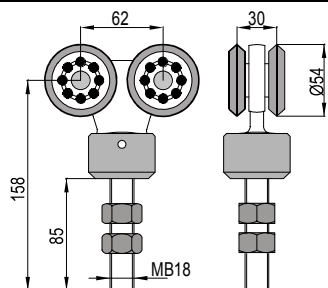

Rotating trolley with 4 wheels.
Chariot pivotant à 4 roulements.

4RGS

Girevole - con cuscinetti cementati
Slewing - with cemented bearings
Pivotant - coussinets cements

ART.	Confez. Box	Peso Kg Weight
4RGS	4	1,800

CARRELLO FISSO A 2 RUOTE CON CERNIERA

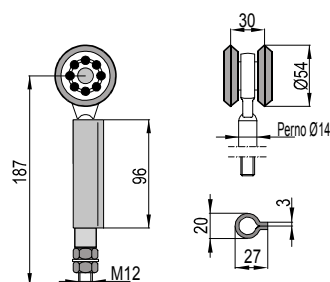
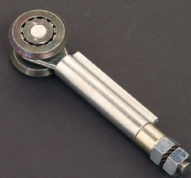

Fix trolley with 2 wheels , and hinge.
Chariot fixe à 2 roulements , avec charniere.

2RGM

Fisso - cuscinetti cementati
Fix - cemented bearings
Fixe - coussinets cements

ART.	Confez. Box	Peso Kg Weight
2RGM	12	0,820

CARRELLO FISSO A 4 RUOTE CON CERNIERA

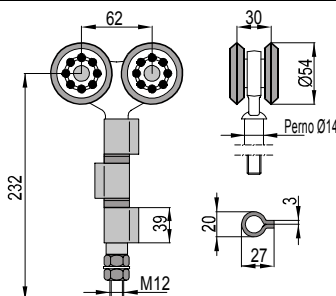

Fix trolley with 4 wheels , and hinge.
Chariot fixe à 4 roulements , avec charniere.

4RGM

Fisso - cuscinetti cementati
Fix - cemented bearings
Fixe - coussinets cements

ART.	Confez. Box	Peso Kg Weight
4RGM	6	1,420

CARRELLO LATERALE A 4 RUOTE CON CERNIERA

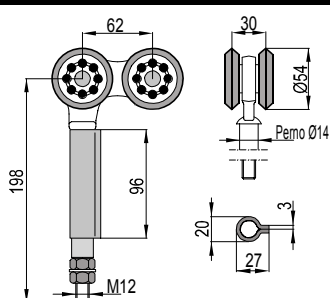

Lateral trolley with 4 wheels , and hinge.
Chariot à 4 roulements , avec charniere.

4RGMT

Fisso - cuscinetti cementati
Fix - cemented bearings
Fixe - coussinets cements

ART.	Confez. Box	Peso Kg Weight
4RGMT	6	1,380

PERNO GUIDA INFERIORE CON OLIVA E CERNIERA

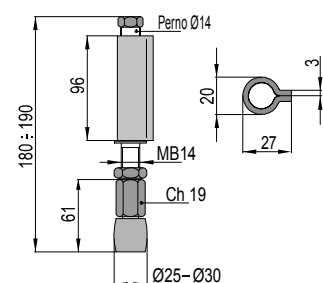

Lower guide pin with olive and hinge.
Pivot guide inferieur avec olive et charniere.

ART.	Confez. Box	Peso Kg Weight
309M-25	20	0,460
309M-30	20	0,500

PERNO GUIDA INFERIORE CON OLIVA E CERNIERA

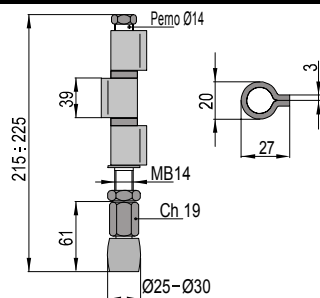

Lower guide pin with olive and hinge .

Pivot guide inferieur avec olive et charniere .

ART.	Confez. Box	Peso Kg Weight	
309M/3-25	20	0,540	
309M/3-30	20	0,580	

CERNIERA A 3 ALI SU CUSCINETTI REGGIPINTA CEMENTATI

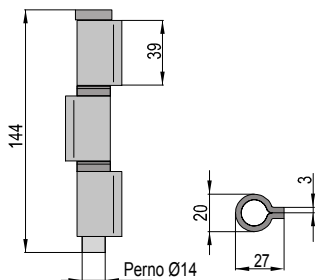

Hinge with 3 wings, on thrust cemented bearings .

Charnière à 3 ailes, sur roulements cimentés.

ART.	Confez. Box	Peso Kg Weight	
1700/3C	10	0,370	

PIASTRA GIREVOLE SU SFERE

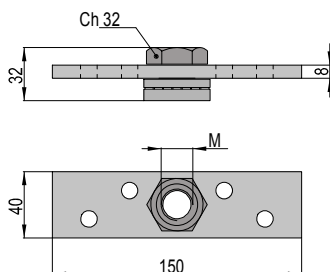
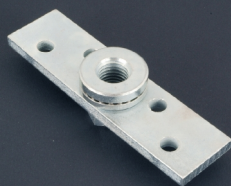

Rotating plate on thrust spheres.

Platine articulée sur billes.

ART.	M	Confez. Box	Peso Kg Weight	
209S	20	20	0,460	
209S/18	18	20	0,460	

PIASTRA FISSA CON OLIVA GIREVOLE IN OTTONE

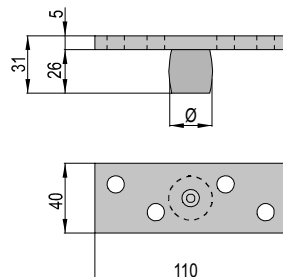
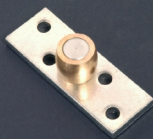

Fix plate with rotating brass olive.

Platine fixe avec olive articulée en laiton.

ART.	Ø	Confez. Box	Peso Kg Weight	
309/25	25	25	0,270	
309/30	30	25	0,310	

PERNO GUIDA CON OLIVA IN OTTONE

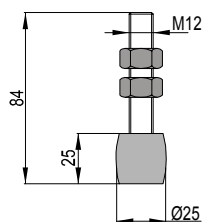

Guide pin with brass olive.

Pivot guide avec olive en laiton.

ART.	Confez. Box	Peso Kg Weight	
311P	50	0,150	

DEVIATORE CON RULLO DI GUIDA

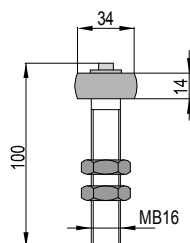

Guide pin with roller .

Deviateur avec rouleau de guide .

ART.	Confez. Box	Peso Kg Weight	
309D	25	0,240	



FERMO DI ARRESTO CON PARACOLPO IN GOMMA

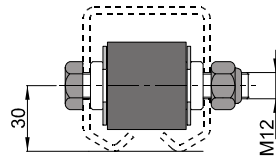

Back stop with rubber buffer.

Ferme d'arrêt avec butoir en gomme .

ART.	Confez. Box	Peso Kg Weight
475	6	0,250

BLOCCHETTO GUIDA

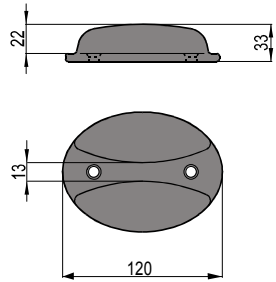

Meeting point.

Bloc guide.

ART.	Confez. Box	Peso Kg Weight
BG/2000	12	1,370

ATTACCO LATERALE A FASCIA REGISTRABILE

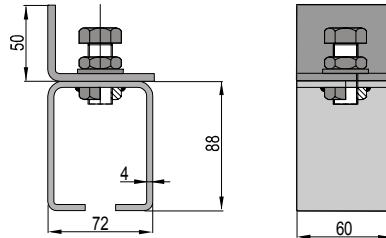

Lateral adjustable support.

Support lateral avec réglage.

ART.	Confez. Box	Peso Kg Weight
ALG9	10	0,700

ATTACCO A SOFFITTO A FASCIA REGISTRABILE

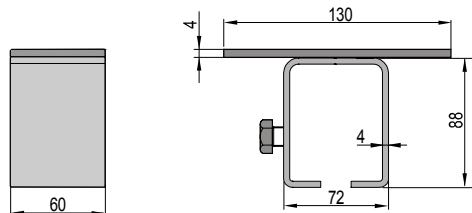

Adjustable support.

Support pour plafond avec réglage.

ART.	Confez. Box	Peso Kg Weight
ASG9	10	0,750

GUIDA INFERIORE IN ACCIAIO

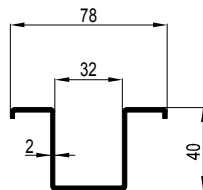

Lunghezza = 6 m
Length = 6 m
Longueur = 6 m

Lower guide in steel.

Rail guide inferieur en acier.

ART.	Confez. Box	Peso Kg Weight
G8I	36 m n° 6x6 m	Kg/m 2,730

*Esempio di applicazione per ante a libro.
L'applicazione è valida per le serie Sempione e Frejus.*

*Application example for folding wings.
The application is valid for Sempione and Frejus series.*

*Exemple d'application pour vantaux pliantes.
L'application est valide pour les séries Sempione et Frejus.*





PETTITI GIUSEPPE s.p.a.

SERIE FREJUS

PORTATA	Per coppia di carrelli
CAPACITY	For each pair of trolleys
PORTEE	Pour couple de chariots
Kg 200	a 2 cuscinetti with 2 bearings a 2 coussinets
Kg 650	a 4 cuscinetti with 4 bearings a 4 coussinets

CARRELLI ED ACCESSORI PER MONOROTAIA G10Z

TROLLEYS AND ACCESSORIES FOR RAIL G10Z

CHARIOTS ET ACCESSOIRES POUR MONORAIL G10Z

MONOROTAIA IN ACCIAIO ZINCATO

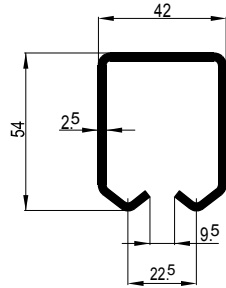

Lunghezza = 6 m
Length = 6 m
Longueur = 6 m

Rail in zinked steel.

Monorail en acier zingue .

ART.	Confez. Box	Peso Kg Weight	
G10Z	24 m n° 4x6 m	Kg/m 3,200	

CARRELLO FISSO A 2 RUOTE

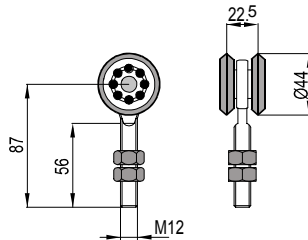

Fix trolley with 2 wheels.

Chariot fixe à 2 roulements.

2RP	Fisso - cuscinetti cementati Fix - cemented bearings Fixe - coussinets cémentes
2RP/C	Fisso - cuscinetti zincati Fix - zinked bearings Fixe - coussinets zingue

ART.	Confez. Box	Peso Kg Weight	
2RP	20	0,290	
2RP/C	20	0,290	

CARRELLO FISSO A 4 RUOTE

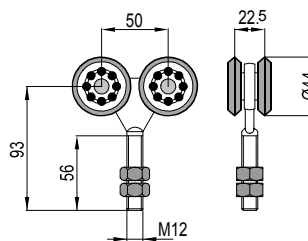

Fix trolley with 4 wheels.

Chariot fixe à 4 roulements.

4RP	Fisso - cuscinetti cementati Fix - cemented bearings Fixe - coussinets cémentes
4RP/C	Fisso - cuscinetti zincati Fix - zinked bearings Fixe - coussinets zingue

ART.	Confez. Box	Peso Kg Weight	
4RP	10	0,550	
4RP/C	10	0,540	

CARRELLO FISSO A 2 RUOTE CON CUSCINETTI

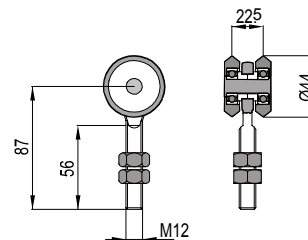

Fix trolley with 2 wheels with bearings.

Chariot fixe à 2 roulements avec coussinets.

2RP/CU	Fisso - con cuscinetti Fix - with bearings Fixe - avec des coussinets
---------------	---

ART.	Confez. Box	Peso Kg Weight	
2RP/CU	8	0,290	

CARRELLO FISSO A 4 RUOTE CON CUSCINETTI

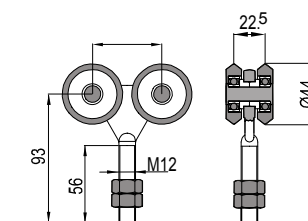

Fix trolley with 4 wheels with bearings.

Chariot fixe à 4 roulements avec coussinets.

4RP/CU	Fisso - con cuscinetti Fix - with bearings Fixe - avec des coussinets
---------------	---

ART.	Confez. Box	Peso Kg Weight	
4RP/CU	4	0,550	

CARRELLO GIREVOLE A 2 RUOTE

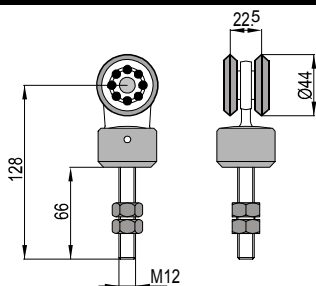

Rotating trolley with 2 wheels.

Chariot pivotant à 2 roulements

2RPS

Girevole - con cuscinetti cementati
Slewing - with cemented bearings
Pivotant - coussinets cements

ART.

Confez. Box

Peso Kg Weight

2RPS

10

0,580

CARRELLO GIREVOLE A 4 RUOTE

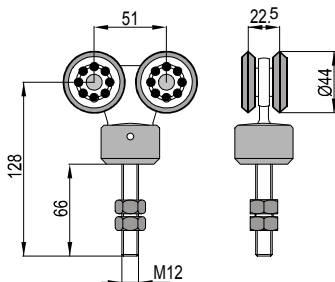

Rotating trolley with 4 wheels.

Chariot pivotant à 4 roulements.

4RPS

Girevole - con cuscinetti cementati
Slewing - with cemented bearings
Pivotant - coussinets cements

ART.

Confez. Box

Peso Kg Weight

4RPS

6

0,900

CARRELLO FISSO A 2 RUOTE CON CERNIERA

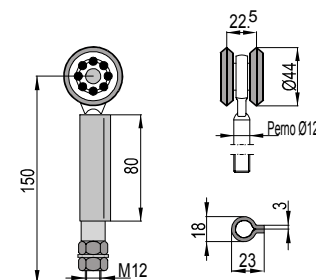

Fix trolley with 2 wheels, and hinge.

Chariot fixe à 2 roulements, avec charniere.

2RPM

Fisso - cuscinetti cementati
Fix - cemented bearings
Fixe - coussinets cements

ART.

Confez. Box

Peso Kg Weight

2RPM

20

0,470

CARRELLO FISSO A 4 RUOTE CON CERNIERA

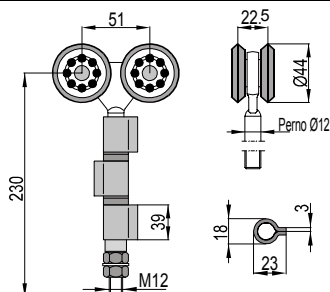

Fix trolley with 4 wheels, and hinge.

Chariot fixe à 4 roulements, avec charniere.

4RPM

Fisso - cuscinetti cementati
Fix - cemented bearings
Fixe - coussinets cements

ART.

Confez. Box

Peso Kg Weight

4RPM

12

0,830

CARRELLO LATERALE A 4 RUOTE CON CERNIERA

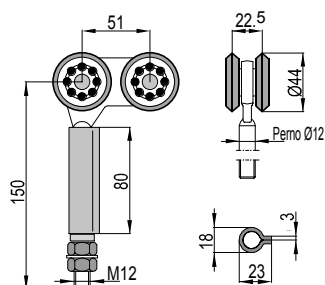

Lateral trolley with 4 wheels, with hinge.

Chariot laterale à 4 roulements, avec charniere.

4RPMT

Fisso - cuscinetti cementati
Fix - cemented bearings
Fixe - coussinets cements

ART.

Confez. Box

Peso Kg Weight

4RPMT

10

0,470

PERNO GUIDA INFERIORE CON OLIVA E CERNIERA

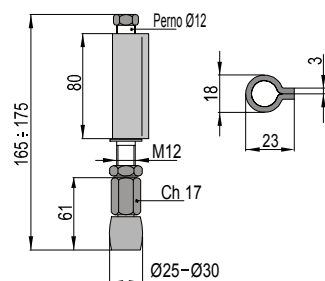

Lower guide pin with olive and hinge.

Pivot guide inferieur avec olive et charniere.

ART.

Confez. Box

Peso Kg Weight

310M-25

25

0,340

310M-30

25

0,380

PERNO GUIDA INFERIORE CON OLIVA E CERNIERA

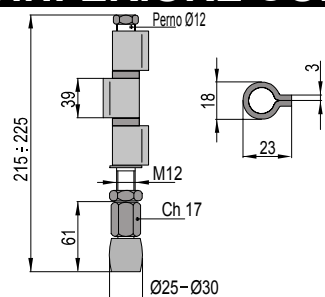

Lower guide pin with olive and hinge.

Pivot guide inferieur avec olive et charniere.

ART.	Confez. Box	Peso Kg Weight	
310M/3-25	25	0,440	
310M/3-30	25	0,480	

CERNIERA A 3 ALI SU CUSCINETTI REGGISPINTA CEMENTATI

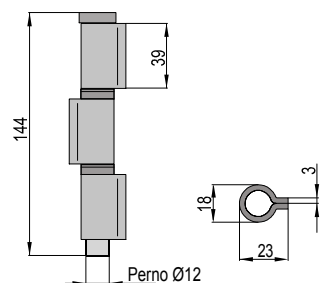

Hinge with 3 short wings, on thrust cemented bearings.

Charnière en acier à 3 ailes courtes, sur roulements cémentés.

ART.	Confez. Box	Peso Kg Weight	
1750/3C	10	0,280	

PIASTRA GIREVOLE SU SFERE

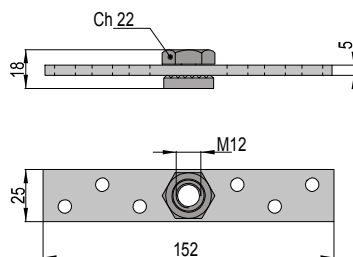

Rotating plate on balls.

Platine articulée sur billes.

ART.	Confez. Box	Peso Kg Weight	
210S	50	0,170	

PIASTRA FISSA CON OLIVA GIREVOLE IN OTTONE

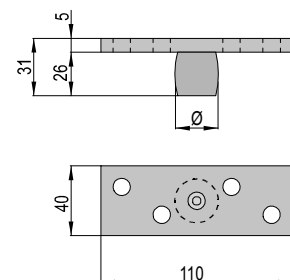

Fix plate with rotating olive in brass.

Platine fixe avec olive articulée en laiton.

ART.	Ø	Confez. Box	Peso Kg Weight	
309/25	25	25	0,270	
309/30	30	25	0,310	

PERNO GUIDA CON OLIVA IN OTTONE

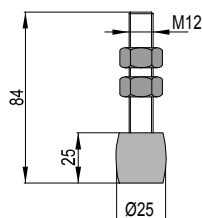

Guide pin with olive in brass.

Pivot guide avec olive en laiton.

ART.	Confez. Box	Peso Kg Weight	
311P	50	0,150	

DEVIATORE CON RULLO DI GUIDA

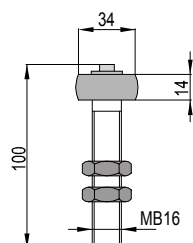

Guide pin with roller.

Deviateur avec rouleau de guide.

ART.	Confez. Box	Peso Kg Weight	
309D	25	0,240	

FERMO DI ARRESTO CON PARACOLPO IN GOMMA

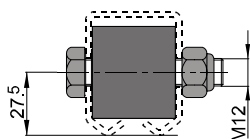

Back stop with rubber buffer.

Ferme d'arrêt avec butoir en gomme .

ART.	Confez. Box	Peso Kg Weight	
465	6	0,200	

BLOCCHETTO GUIDA

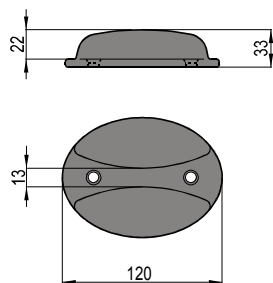

Meeting point.

Bloc guide.

ART.	Confez. Box	Peso Kg Weight	
BG/2000	12	1,370	

ATTACCO LATERALE A FASCIA REGISTRABILE

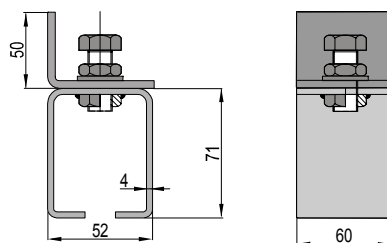

Adjustable lateral support.

Support pour latéral avec réglage.

ART.	Confez. Box	Peso Kg Weight	
ALG10	10	0,600	

ATTACCO A SOFFITTO A FASCIA REGISTRABILE

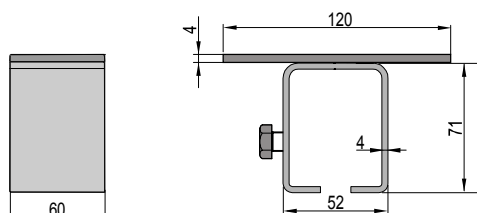

Adjustable support.

Support pour plafond avec réglage.

ART.	Confez. Box	Peso Kg Weight	
ASG10	10	0,650	

GUIDA INFERIORE IN ACCIAIO

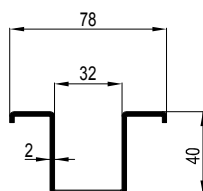

Lunghezza = 6 m
Length = 6 m
Longueur = 6 m

Lower guide in steel.

Rail guide inferieur en acier.

ART.	Confez. Box	Peso Kg Weight	
G8I	36 m n° 6x6 m	Kg/m 2,730	



PETTITI GIUSEPPE s.p.a.

SERIE MINILUCE

PORTATA	Per coppia di carrelli
CAPACITY	For each pair of trolleys
PORTEE	Pour couple de chariots
Kg 60	a 2 cuscinetti with 2 bearings a 2 coussinets
Kg 85	a 4 cuscinetti with 4 bearings a 4 coussinets

CARRELLI ED ACCESSORI PER MONOROTAIA G12A - G12Z

TROLLEYS AND ACCESSORIES FOR RAIL G12A - G12Z

CHARIOTS ET ACCESSOIRES POUR MONORAIL G12A - G12Z

MONOROTAIA IN ALLUMINIO GREZZO

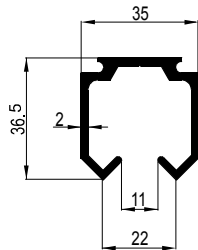

Lunghezza = 6 m
Length = 6 m
Longueur = 6 m

Rail in aluminium

Monorail en aluminium.

ART.	Confez. Box	Peso Kg Weight
G12A	60 m n° 10x6 m	Kg/m 0,750

MONOROTAIA IN ACCIAIO ZINCATO, FORATA

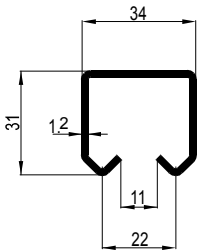
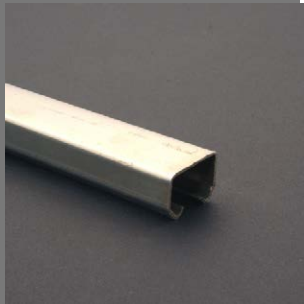

Lunghezza = 6 m
Length = 6 m
Longueur = 6 m

Drilled rail in zinked steel.

Monorail percé en acier zingue.

ART.	Confez. Box	Peso Kg Weight
G12Z	72 m n° 12x6 m	Kg/m 1,008

CARRELLO FISSO A 2 RUOTE

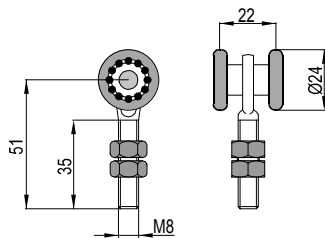

Fix trolley with 2 wheels.

Chariot fixe à 2 roul.

2RPP	Fisso - cuscinetti in acciaio Fix - steel bearings Fixe - coussinets en acier
S2RPP	Fisso - cuscinetti in nylon Fix - nylon bearings Fixe - coussinets en nylon

ART.	Confez. Box	Peso Kg Weight
2RPP	60	0,070
S2RPP	60	0,060

CARRELLO FISSO A 4 RUOTE, STAFFA IN ZAMA

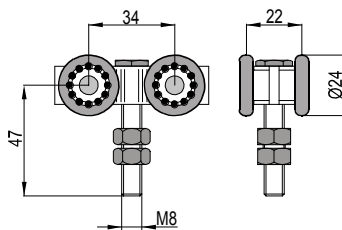

Fix trolley with 4 wheels, bracket in zama.

Chariot fixé a 4 roul, etrier en zama.

4RPP	Fisso - cuscinetti in acciaio Fix - steel bearings Fixe - coussinets en acier
S4RPP	Fisso - cuscinetti in nylon Fix - nylon bearings Fixe - coussinets en nylon

ART.	Confez. Box	Peso Kg Weight
4RPP	30	0,125
S4RPP	30	0,095

CARRELLO FISSO A 4 RUOTE, STAFFA IN ACCIAIO ZINCATO

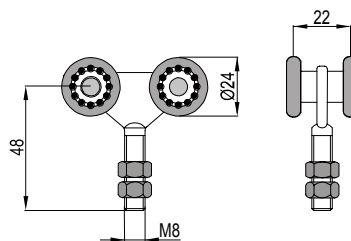

**NOVITÀ - NEW
NOUVEAU**

Fix trolley with 4 wheels, bracket in zinked steel.

Chariot fixe a 4 roues etrier en acier zingue.

4RPPZ	Fisso - cuscinetti in acciaio Fix - steel bearings Fixe - coussinets en acier
S4RPPZ	Fisso - cuscinetti in nylon Fix - nylon bearings Fixe - coussinets en nylon

ART.	Confez. Box	Peso Kg Weight
4RPPZ	30	0,125
S4RPPZ	30	0,095

CARRELLO GIREVOLE A 2 RUOTE

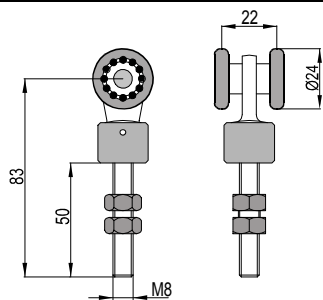

Rotating trolley with 2 wheels.

Chariot pivotant à 2 rouls.

2RPPS	Girevole - cuscinetti in acciaio Rotating - steel bearings Pivotant - coussinets en acier	
S2RPPS	Girevole - cuscinetti in nylon Rotating - nylon bearings Pivotant - coussinets en nylon	

ART.	Confez. Box	Peso Kg Weight
2RPPS	60	0,115
S2RPPS	60	0,100

CARRELLO GIREVOLE IN ALLUMINIO A 4 RUOTE

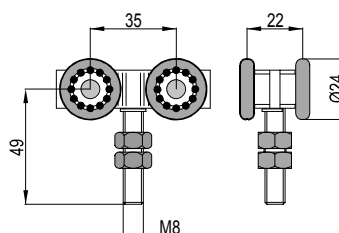

Rotating trolley in aluminium with 4 wheels.

Chariot pivotant en aluminium à 4 roulements.

4RPPS	Girevole - cuscinetti in acciaio Rotating - steel bearings Pivotant - coussinets en acier	
S4RPPS	Girevole - cuscinetti in nylon Rotating - nylon bearings Pivotant - coussinets en nylon	

ART.	Confez. Box	Peso Kg Weight
4RPPS	30	0,125
S4RPPS	30	0,095

STAFFA DI FISSAGGIO ANTA IN ACCIAIO ZINCATO

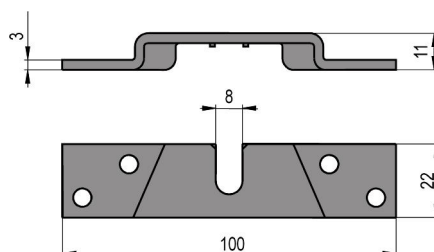

Fixing bracket in zinked steel.

Platine de fixation en acier zingué.

ART.	Confez. Box	Peso Kg Weight
STS303MSZ	30	0,048

CARRELLO FISSO A 2 RUOTE

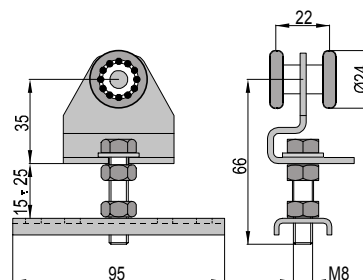
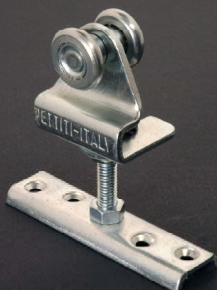

Fix trolley with 2 wheels.

Chariot fixe à 2 roulements.

2RM	Fisso - cuscinetti in acciaio Fix - steel bearings Fixe - coussinets en acier	
S2RM	Fisso - cuscinetti in nylon Fix - nylon bearings Fixe - coussinets en nylon	

ART.	Confez. Box	Peso Kg Weight
2RM	60	0,170
S2RM	60	0,160

CARRELLO FISSO A 4 RUOTE

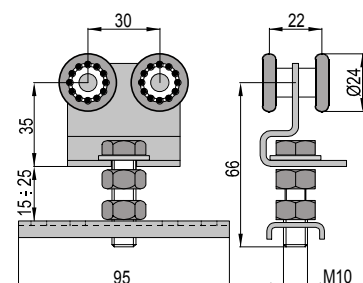

Fix trolley with 4 wheels.

Chariot fixe à 4 roulements.

4RM	Fisso - cuscinetti in acciaio Fix - steel bearings Fixe - coussinets en acier	
S4RM	Fisso - cuscinetti in nylon Fix - nylon bearings Fixe - coussinets en nylon	

ART.	Confez. Box	Peso Kg Weight
4RM	30	0,250
S4RM	30	0,225

CARRELLO GIREVOLE A 2 RUOTE

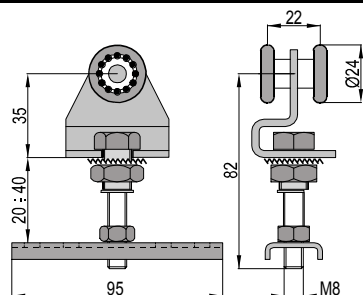

Rotating trolley with 2 wheels.

Chariot pivotant à 2 roulements.

2RMG	Girevole - cuscinetti in acciaio Rotating - steel bearings Pivotant - coussinets en acier	
S2RMG	Girevole - cuscinetti in nylon Rotating - nylon bearings Pivotant - coussinets en nylon	

ART.	Confez. Box	Peso Kg Weight
2RMG	30	0,195
S2RMG	30	0,180

CARRELLO GIREVOLE A 4 RUOTE

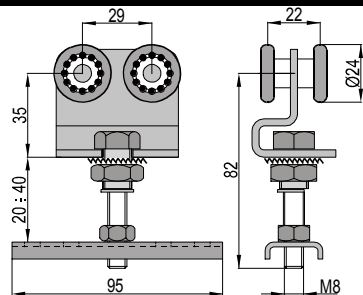
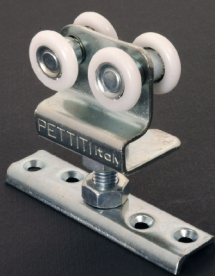

Rotating trolley with 4 wheels.
Chariot pivotant à 4 roulements.

4RMG	Girevole - cuscinetti in acciaio Rotating - steel bearings Pivotant - coussinets en acier
S4RMG	Girevole - cuscinetti in nylon Rotating - nylon bearings Pivotant - coussinets en nylon

ART.	Confez. Box	Peso Kg Weight
4RMG	30	0,260
S4RMG	30	0,235

CARRELLO A 2 RUOTE CON PIASTRA

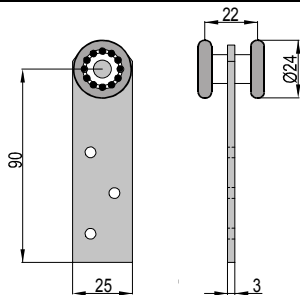

Trolley with 2 wheels, with plate.
Chariot à 2 roulements, et plaque.

V1L2	Fisso - cuscinetti in acciaio Fix - steel bearings Fixe - coussinets en acier
SV1L2	Fisso - cuscinetti in nylon Fix - nylon bearings Fixe - coussinets en nylon

ART.	Confez. Box	Peso Kg Weight
V1L2	30	0,095
SV1L2	30	0,080

CARRELLO FISSO A 2 RUOTE CON STAFFE MOBILI

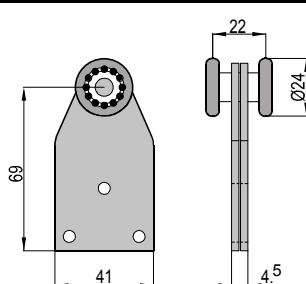

Fix trolley with 2 wheels, movable brackets.
Chariot fixe à 2 roulements, avec etriers mobiles.

V2	Fisso - cuscinetti in acciaio Fix - steel bearings Fixe - coussinets en acier
-----------	---

ART.	Confez. Box	Peso Kg Weight
V2	50	0,120

CARRELLO FISSO A 2 RUOTE CON STAFFA FISSA

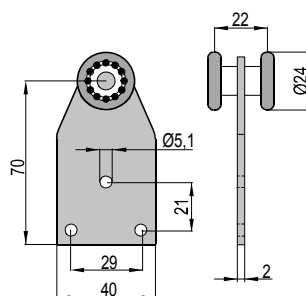

Fix trolley with 4 wheels, and fix plate.
Chariot fixe à 4 roulements, avec etrier.

V2L	Fisso - cuscinetti in acciaio Fix - steel bearings Fixe - coussinets en acier
------------	---

ART.	Confez. Box	Peso Kg Weight
V2L	50	0,080

STAFFA IN PLASTICA PER CARRELLO V2L

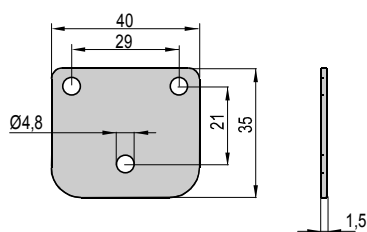

Plastic bracket for trolley V2L.
Platine en plastique pour chariot V2L.

ART.	Confez. Box	Peso Kg Weight
ST40X35N	150	0,002

RIBATTINO PER STAFFA IN PLASTICA ST40X35N

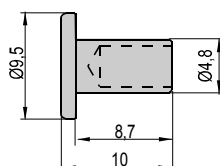

Rivet for plastic bracket ST40X35N.
Rivet pour platine en plastique ST40X35N.

ART.	Confez. Box	Peso Kg Weight
PER9,5X10Z	2.000	0,001

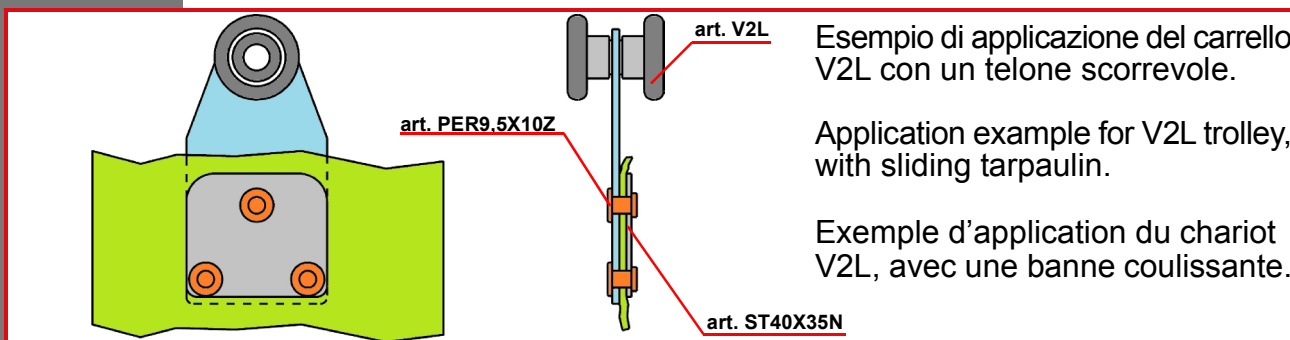

Esempio di applicazione del carrello V2L con un telone scorrevole.

Application example for V2L trolley, with sliding tarpaulin.

Exemple d'application du chariot V2L, avec une banne coulissante.

CARRELLO FISSO A 4 RUOTE

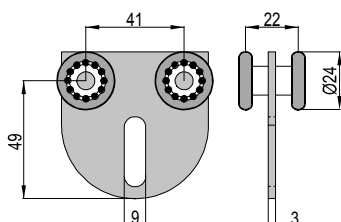

Fix trolley with 4 wheels.

Chariot fixe à 4 roulements.

4MLI	Fisso - cuscinetti in acciaio Fix - steel bearings Fixe - coussinets en acier
S4MLI	Fisso - cuscinetti in nylon Fix - nylon bearings Fixe - coussinets en nylon

ART.	Confez. Box	Peso Kg Weight
4MLI	30	0,150
S4MLI	30	0,120

CARRELLO FISSO A 4 RUOTE PER TRASPORTO PIATTINA

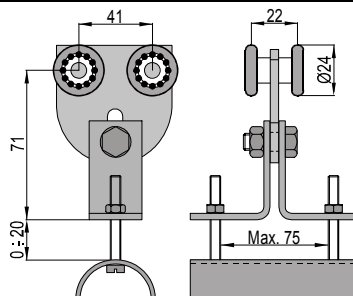

Fix trolley with 4 wheels, for strap transport.

Chariot fixe à 4 roulements pour transport de sangle.

4MLP	Fisso - cuscinetti in acciaio Fix - steel bearings Fixe - coussinets en acier
-------------	---

ART.	Confez. Box	Peso Kg Weight
4MLP	10	0,355

FERMO DI ARRESTO CON PARACOLPI IN GOMMA

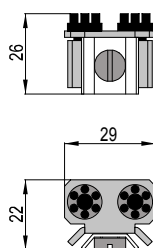

Back stop with rubber buffers.

Ferme d'arrêt avec butoir en gomme.

ART.	Confez. Box	Peso Kg Weight
412	100	0,020

PIASTRA FISSA CON OLIVA GIREVOLE CENTRALE

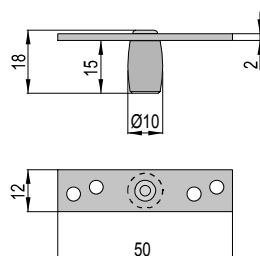

Fix plate with rotating olive.

Platine fixe avec olive articulée.

312B	Piastra in acciaio zincato, oliva in ottone. Plate in zinked steel, olive in brass. Platine en acier zingué, olive en laiton.
312BN/INOX	Piastra in acciaio inox, oliva in nylon. Plate in stainless steel, olive in nylon. Platine en acier inox, olive en nylon.

ART.	Confez. Box	Peso Kg Weight
312B	50	0,015
312BN/INOX	50	0,015

INOX - STAINLESS

PIASTRA FISSA CON OLIVA GIREVOLE LATERALE

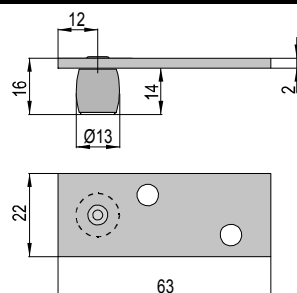
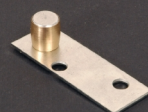

Fix plate with lateral rotating live in brass.

Platine fixe avec olive pivotante en laiton.

ART.	Confez. Box	Peso Kg Weight
312A	80	0,045

GUIDA INFERIORE IN NYLON

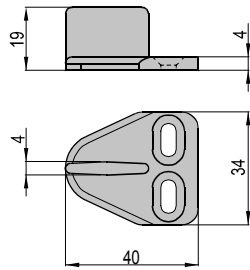

Lower guide in nylon.

Guide inférieure en nylon.

ART.	Confez. Box	Peso Kg Weight
312	60	0,006

GUIDA INFERIORE IN NYLON

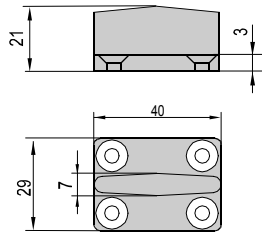

Lower guide in nylon.

Guide inférieure en nylon.

ART.	Confez. Box	Peso Kg Weight
312/A	60	0,006

SUPPORTO LATERALE PER MONOROTAIA G12Z

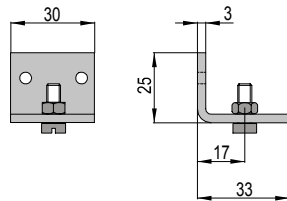

Side support for rail G12Z.

Supporte lateral pour monorail G12Z.

ART.	Confez. Box	Peso Kg Weight
112PN	24	0,040

SUPPORTO LATERALE PER MONOROTAIA G12Z

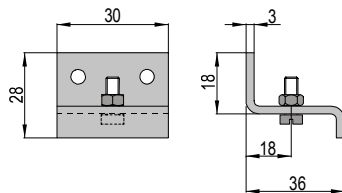

Side support for rail G12Z.

Supporte lateral pour monorail G12Z.

ART.	Confez. Box	Peso Kg Weight
112PZ	24	0,036

SUPPORTO LATERALE PER MONOROTAIA G12A

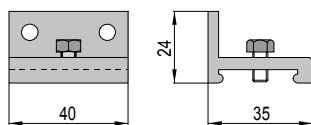
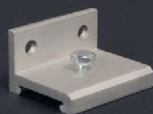

Side support for rail G12A.

Support lateral pour rail G12A.

ART.	Confez. Box	Peso Kg Weight
LS 120V	30	0,030

ATTACCO LATERALE REGISTRABILE

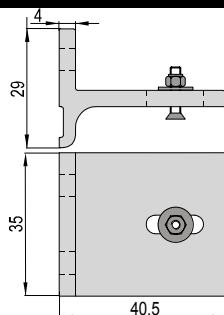

Lateral adjustable support.

Support de fixation lateral réglable.

ART.	Confez. Box	Peso Kg Weight
LS 40-120	20	0,030

GUIDA INFERIORE IN ALLUMINIO GREZZO

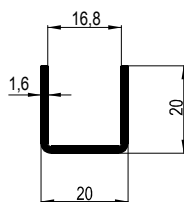
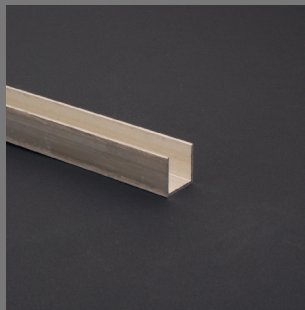

Lunghezza = 6 m
Length = 6 m
Longueur = 6 m

Lower guide in aluminium.
Guide inférieure en aluminium.

ART.	Confez. Box	Peso Kg Weight	
GIM	72 m n°12x6 m	Kg/m 0,235	

SET SERIE MINILUCE



CONFEZIONI STANDARD PER MONOROTAIA G12A - G12Z
STANDARD PACKINGS FOR MONORAIL G12A - G12Z
CONDIT. STANDARD POUR RAIL G12A - G12Z

Set in contenitore di cartone composto da:
n. 2 carrelli completi (art. 4RM)
n. 2 fermi d'arresto (art. 412)
n. 1 guida inferiore (art. 312)

Set in carton box including:
n. 2 complete trolleys (art. 4RM)
n. 2 backstops (art. 412)
n. 1 lower guide (art. 312)

Set en boîte de carton composé par:
n. 2 chariots complets (art. 4RM)
n. 2 fermes d'arrêt (art. 412)
n. 1 guide inférieure (art. 312)

ART.	Confez. Box	Peso Kg Weight	
SET 4RM	24	0,575	

SET SERIE MINILUCE



CONFEZIONI STANDARD PER MONOROTAIA G12A - G12Z
STANDARD PACKINGS FOR MONORAIL G12A - G12Z
CONDIT. STANDARD POUR RAIL G12A - G12Z

Set in contenitore di cartone composto da:
n. 2 carrelli completi (art. S4RM)
n. 2 fermi d'arresto (art. 412)
n. 1 guida inferiore (art. 312)

Set in carton box including:
n. 2 complete trolleys (art. S4RM)
n. 2 backstop (art. 412)
n. 1 lower guide (art. 312)

Set en boîte de carton composé par:
n. 2 chariots complets (art. S4RM)
n. 2 fermes d'arrêt (art. 412)
n. 1 guide inférieur (art. 312)

ART.	Confez. Box	Peso Kg Weight	
SET S4RM	24	0,520	

**L'applicazione è valida per la serie Miniluce - The application is valid for Miniluce serie
L'application est valide pour la série Miniluce**

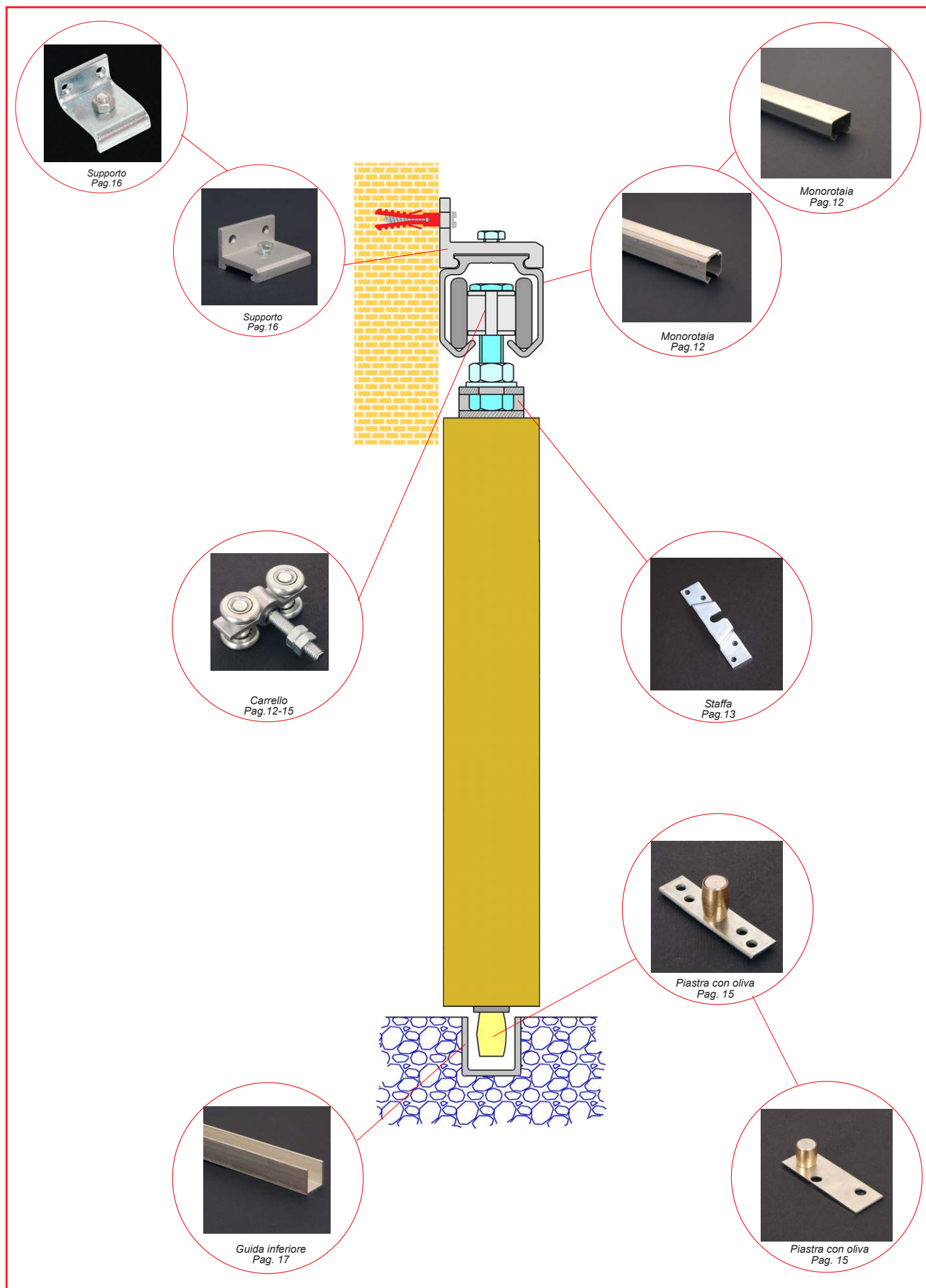



PETTITI GIUSEPPE s.p.a.

SERIE MINILUCE VERTICAL

PORTATA	Per coppia di carrelli
CAPACITY	For each pair of trolleys
PORTEE	Pour couple de chariots
Kg 30	a 1 cuscinetto with 1 bearing a 1 coussinet

CARRELLI ED ACCESSORI PER MONOROTAIA G14Z

TROLLEYS AND ACCESSORIES FOR RAIL G14Z

CHARIOTS ET ACCESSOIRES POUR MONORAIL G14Z

MONOROTAIA IN ACCIAIO ZINCATO

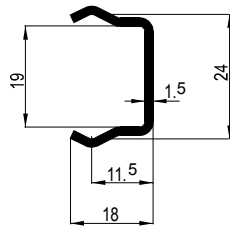
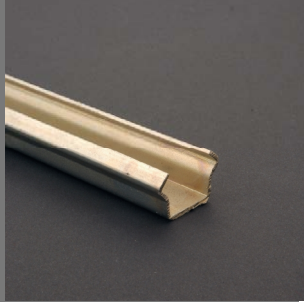

Lunghezza = 6 m
Length = 6 m
Longueur = 6 m

Rail in zinked steel.

Monorail en acier zingué.

ART.	Confez. Box	Peso Kg Weight
G14Z	72 m n° 12x6 m	Kg/m 0,650

MONOROTAIA DOPPIA IN ALLUMINIO GREZZO

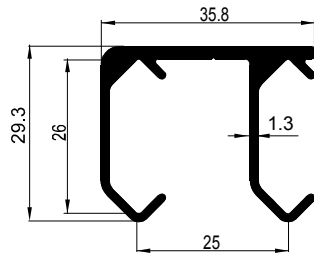
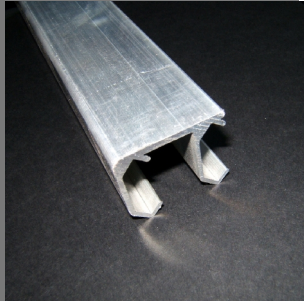

Lunghezza = 6 m
Length = 6 m
Longueur = 6 m

Double rail in aluminium.

Double monorail en aluminium.

ART.	Confez. Box	Peso Kg Weight
G14AX2	72 m n° 12x6 m	Kg/m 0,527

CARRELLO FISSO A 1 RUOTA

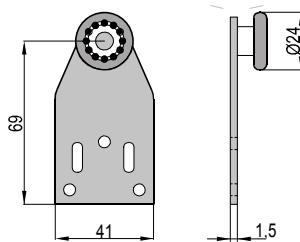

Fix trolley with 1 wheel.

Chariot fixe à 1 roulement.

V1	Fisso - cuscinetti in acciaio Fix - steel bearings Fixe - coussinets en acier
SV1	Fisso - cuscinetti in nylon Fix - nylon bearings Fixe - coussinets en nylon

ART.	Confez. Box	Peso Kg Weight
V1	50	0,060
SV1	50	0,055

CARRELLO FISSO A 1 RUOTA

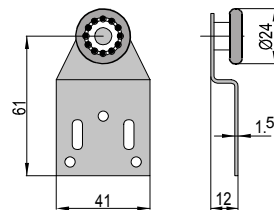

Fix trolley with 1 wheel.

Chariot fixe à 1 roulement.

V1A	Fisso - cuscinetti in acciaio Fix - steel bearings Fixe - coussinets en acier
SV1A	Fisso - cuscinetti in nylon Fix - nylon bearings Fixe - coussinets en nylon

ART.	Confez. Box	Peso Kg Weight
V1A	80	0,060
SV1A	80	0,055

CARRELLO FISSO A 1 RUOTA

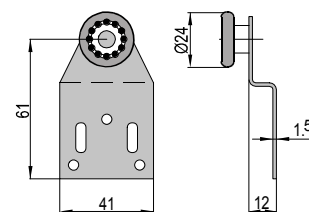

Fix trolley with 1 wheel.

Chariot fixe à 1 roulement.

V1A/O	Fisso - cuscinetti in acciaio Fix - steel bearings Fixe - coussinets en acier
SV1A/O	Fisso - cuscinetti in nylon Fix - nylon bearings Fixe - coussinets en nylon

ART.	Confez. Box	Peso Kg Weight
V1A/O	80	0,060
SV1A/O	80	0,055

CARRELLO FISSO A 1 RUOTA

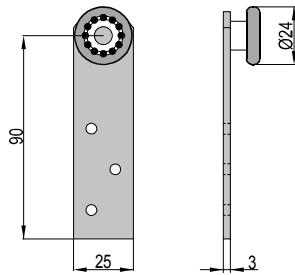

Fix trolley with 1 wheel.
Chariot fixe à 1 roulement.

V1L	Fisso - cuscinetti in acciaio Fix - steel bearings Fixe - coussinets en acier
SV1L	Fisso - cuscinetti in nylon Fixed - nylon bearings Fixe - coussinets en nylon

ART.	Confez. Box	Peso Kg Weight
V1L	50	0,070
SV1L	50	0,065

CARRELLO FISSO A 1 RUOTA

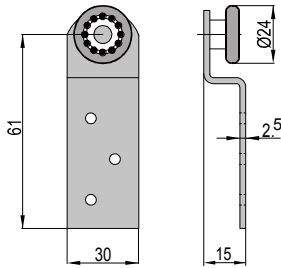

Fix trolley with 1 wheel.
Chariot fixe à 1 roulement.

V1LA	Fisso - cuscinetti in acciaio Fix - steel bearings Fixe - coussinets en acier
SV1LA	Fisso - cuscinetti in nylon Fix - nylon bearings Fixe - coussinets en nylon

ART.	Confez. Box	Peso Kg Weight
V1LA	50	0,070
SV1LA	50	0,065

CARRELLO FISSO A 1 RUOTA

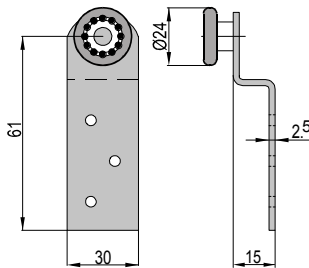

Fix trolley with 1 wheel.
Chariot fixe à 1 roulement.

V1LA/O	Fisso - cuscinetti in acciaio Fix - steel bearings Fixe - coussinets en acier
SV1LA/O	Fisso - cuscinetti in nylon Fix - nylon bearings Fixe - coussinets en nylon

ART.	Confez. Box	Peso Kg Weight
V1LA/O	50	0,070
SV1LA/O	50	0,065

CARRELLO FISSO A 1 RUOTA

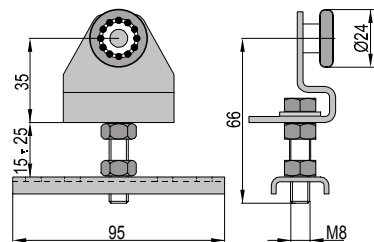

Fix trolley with 1 wheel.
Chariot fixe à 1 roulement.

V1S	Fisso - cuscinetti in acciaio Fix - steel bearings Fixe - coussinets en acier
SV1S	Fisso - cuscinetti in nylon Fix - nylon bearings Fixe - coussinets en nylon

ART.	Confez. Box	Peso Kg Weight
V1S	50	0,155
SV1S	50	0,150

CARRELLO FISSO A 2 RUOTE

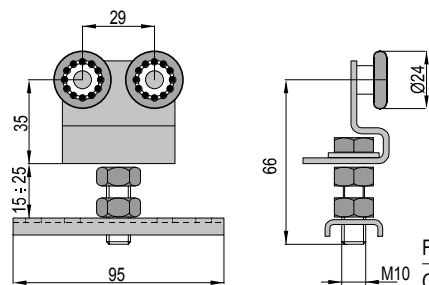

Fix trolley with 2 wheels.
Chariot fixe à 2 roulements.

V2S	Fisso - cuscinetti in acciaio Fix - steel bearings Fixe - coussinets en acier
SV2S	Fisso - cuscinetti in nylon Fix - nylon bearings Fixe - coussinets en nylon

ART.	Confez. Box	Peso Kg Weight
V2S	50	0,230
SV2S	50	0,215

CARRELLO FISSO A 1 RUOTA

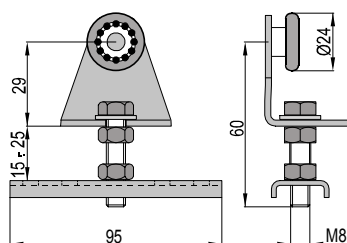

AD ESAURIMENTO
TO EXHAUSTION
À ÉPUISEMENT

Fix trolley with 1 wheel.
Chariot fixe à 1 roulement.

1RMS	Fisso - cuscinetti in acciaio Fix - steel bearings Fixe - coussinets en acier
S1RMS	Fisso - cuscinetti in nylon Fix - nylon bearings Fixe - coussinets en nylon

ART.	Confez. Box	Peso Kg Weight
1RMS	30	0,140
S1RMS	30	0,130

FERMO DI ARRESTO CON PARACOLPO IN GOMMA

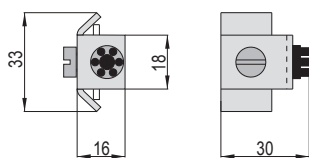

Back stop with rubber buffers.

Ferme d'arret avec butoir en gomme.

ART.	Confez. Box	Peso Kg Weight
414	100	0,020

GUIDA INFERIORE IN PLASTICA

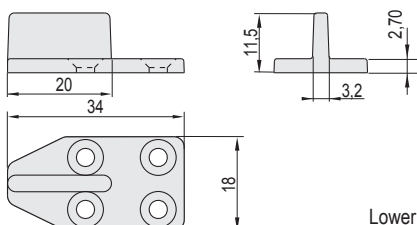

Lower guide in plastic.

Guide inférieur en plastique.

ART.	Confez. Box	Peso Kg Weight
316	50	0,002

GUIDA INFERIORE IN NYLON

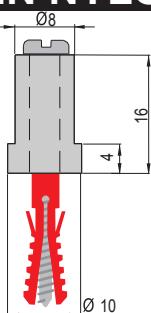

Lower guide in nylon.

Guide inférieure en nylon.

ART.	Confez. Box	Peso Kg Weight
312R	60	0,003

Applicazione con monorotaia doppia.

Application with double rail.

Application avec double rail.

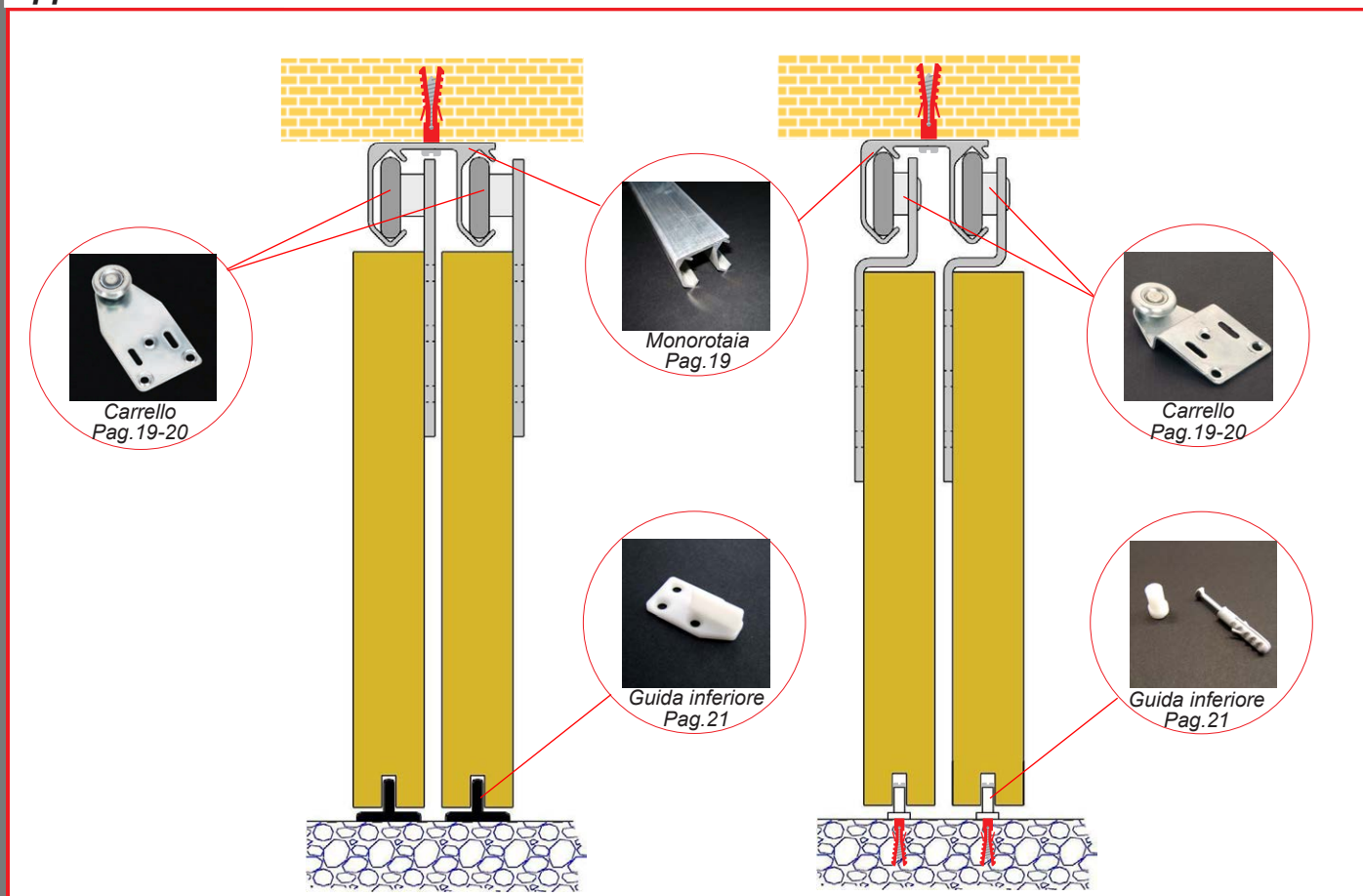



PETTITI GIUSEPPE s.p.a.

SERIE MICRON

PORTATA	Per coppia di carrelli
CAPACITY	For each pair of trolleys
PORTEE	Pour couple de chariots
Kg 30	a 2 cuscinetti with 2 bearings a 2 coussinets

CARRELLI ED ACCESSORI PER MONOROTAIA G16Z

TROLLEYS AND ACCESSORIES FOR RAIL G16Z

CHARIOTS ET ACCESSOIRES POUR MONORAIL G16Z

MONOROTAIA IN ACCIAIO ZINCATO, FORATA

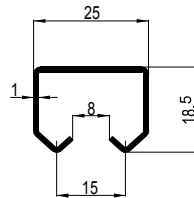

Lunghezza = 6 m
Length = 6 m
Longueur = 6m

Drilled rail in zinked steel.

Monorail percé en acier zingue.

ART.	Confez. Box	Peso Kg Weight
G16Z	90 m n° 15x6 m	Kg/m 0,550

CARRELLO FISSO A 2 RUOTE

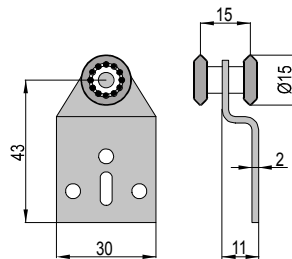

Fix trolley with 2 wheels.

Chariot fixe à 2 roulements.

M1	Fisso - cuscinetti in acciaio Fix - steel bearings Fixe - coussinets en acier
SM1	Fisso - cuscinetti in nylon Fix - nylon bearings Fixe - coussinets en nylon

ART.	Confez. Box	Peso Kg Weight
M1	30	0,030
SM1	30	0,025

CARRELLO FISSO A 2 RUOTE

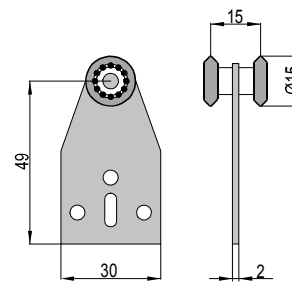

Fix trolley with 2 wheels.

Chariot fixe à 2 roulements.

M1V	Fisso - cuscinetti in acciaio Fix - steel bearings Fixe - coussinets en acier
SM1V	Fisso - cuscinetti in nylon Fix - nylon bearings Fixe - coussinets en nylon

ART.	Confez. Box	Peso Kg Weight
M1V	30	0,035
SM1V	30	0,030

SUPPORTO LATERALE PER MONOROTAIA G16Z

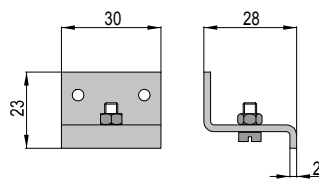

Lateral support in zinked steel.

Support lateral en acier zingue.

ART.	Confez. Box	Peso Kg Weight
116P	25	0,020

FERMO DI ARRESTO IN PLASTICA NERA

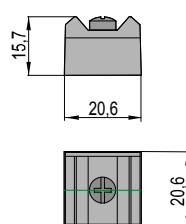
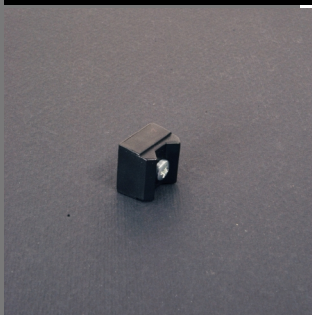

Back stop in plastic.

Ferme d'arrêt en plastique.

ART.	Confez. Box	Peso Kg Weight
416	100	0,010

GUIDA INFERIORE IN PLASTICA

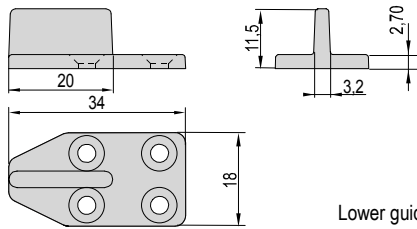

Lower guide in plastic.

Guide inférieur en plastique.

ART.	Confez. Box	Peso Kg Weight
316	50	0,002



PETTITI GIUSEPPE s.p.a.

SERIE MICRON VERTICAL

PORTATA	Per coppia di carrelli
CAPACITY	For each pair of trolleys
PORTEE	Pour couple de chariots
Kg 20	a 1 cuscinetto with 1 bearing a 1 coussinet

CARRELLI ED ACCESSORI PER MONOROTAIA G16VZ

TROLLEYS AND ACCESSORIES FOR RAIL G16VZ

CHARIOTS ET ACCESSOIRES POUR MONORAIL G16VZ

MONOROTAIA IN ACCIAIO ZINCATO

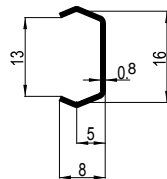
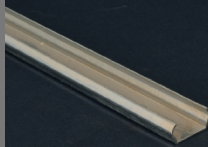

Lunghezza = 6 m

Length = 6 m

Longueur = 6m

Rail in zinked steel.

Monorail en acier zingue.

ART.	Confez. Box	Peso Kg Weight
G16VZ	90 m n° 15x6 m	Kg/m 0,200

CARRELLO FISSO A 1 RUOTA

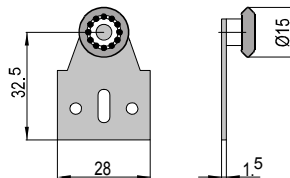

Fix trolley with 1 wheel.

Chariot fixe à 1 roulement.

MV1	Fisso - cuscinetti in acciaio Fixed - steel bearings Fixe - coussinets en acier
SMV1	Fisso - cuscinetti in nylon Fixed - nylon bearings Fixe - coussinets en nylon

ART.	Confez. Box	Peso Kg Weight
MV1	30	0,015
SMV1	30	0,015

CARRELLO FISSO A 1 RUOTA

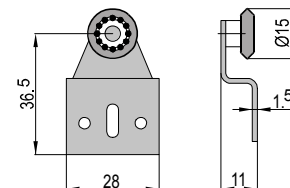

Fix trolley with 1 wheel.

Chariot fixe à 1 roulement.

MV1A	Fisso - cuscinetti in acciaio Fixed - steel bearings Fixe - coussinets en acier
SMV1A	Fisso - cuscinetti in nylon Fixed - nylon bearings Fixe - coussinets en nylon

ART.	Confez. Box	Peso Kg Weight
MV1A	30	0,015
SMV1A	30	0,015

CARRELLO FISSO A 1 RUOTA

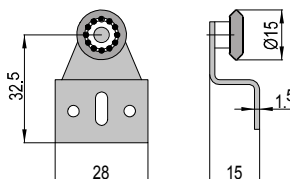

Fix trolley with 1 wheel.

Chariot fixe à 1 roulement.

MV1AA	Fisso - cuscinetti in acciaio Fixed - steel bearings Fixe - coussinets en acier
SMV1AA	Fisso - cuscinetti in nylon Fixed - nylon bearings Fixe - coussinets en nylon

ART.	Confez. Box	Peso Kg Weight
MV1AA	30	0,015
SMV1AA	30	0,015



GUIDA INFERIORE IN PLASTICA

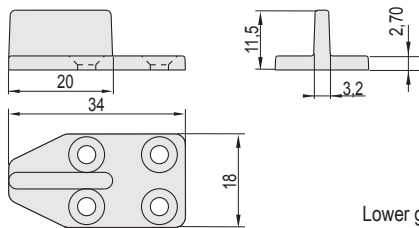

Lower guide in plastic.

Guide inférieure en plastique.

ART.	Confez. Box	Peso Kg Weight
316	50	0,002

L'applicazione è valida per le serie Miniluce Vertical e Micron Vertical.

The application is valid for Miniluce Vertical and Micron Vertical series.

L'application est valide pour les séries Miniluce Vertical et Micron Vertical.

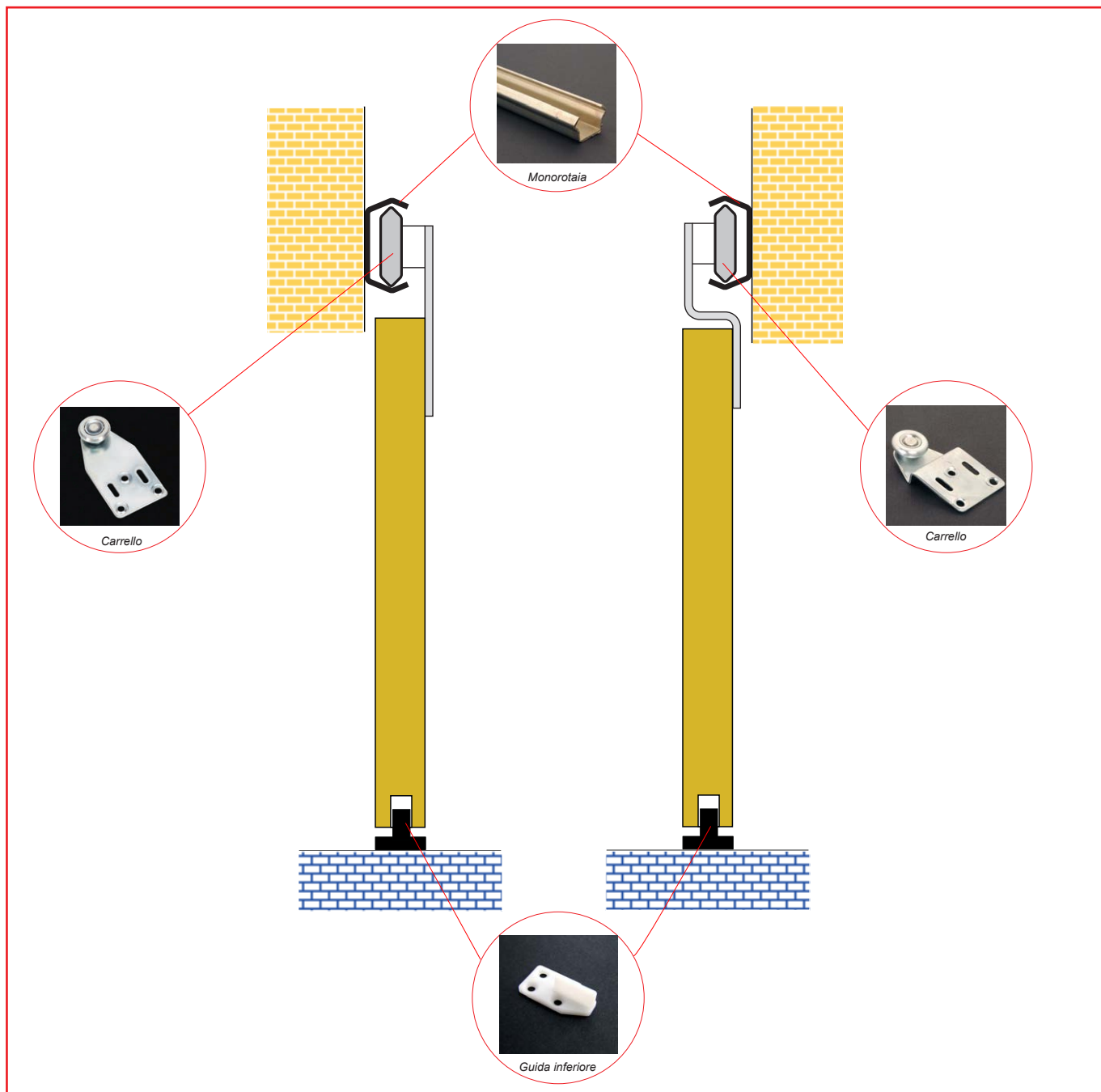



PETTITI GIUSEPPE s.p.a.

SERIE SEMPIONE FRANCE

CARRELLI ED ACCESSORI PER MONOROTAIA G9ZF

TROLLEYS AND ACCESSORIES FOR RAIL G9ZF

CHARIOTS ET ACCESSOIRES POUR MONORAIL G9ZF

PORTATA CAPACITY	Per coppia di carrelli For each pair of trolleys
PORTEE	Pour couple de chariots a 2 cuscinetti with 2 bearings a 2 coussinets a 4 cuscinetti with 4 bearings a 4 coussinets
Kg 400	
Kg 750	

MONOROTAIA IN ACCIAIO ZINCATO

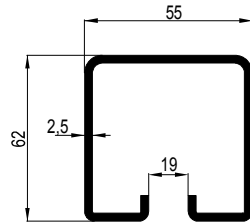
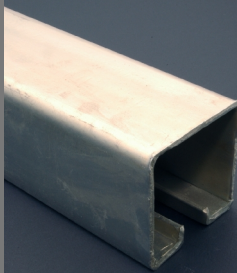

Lunghezza = 6 m
Length = 6 m
Longueur = 6m

Rail in zinked steel .
Monorail en acier zingue.

ART.	Confez. Box	Peso Kg Weight
G9ZF	24 m n° 4x6 m	Kg/m 3,960

CARRELLO FISSO A 2 RUOTE

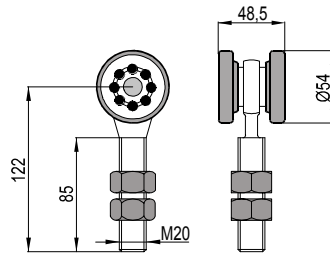

Fix trolley with 2 wheels .
Chariot fixe à 2 roulements.

ART.	Confez. Box	Peso Kg Weight
2RG/CF		

Fisso - cuscinetti zincati
Fix - zinked bearings
Fixe - coussinets zingue

ART.	Confez. Box	Peso Kg Weight
2RG/CF	8	0,750

CARRELLO FISSO A 4 RUOTE

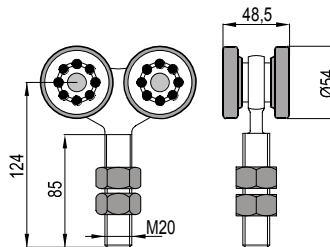

Fix trolley with 4 wheels .
Chariot fixe à 4 roulements.

ART.	Confez. Box	Peso Kg Weight
4RG/CF		

Fisso - cuscinetti zincati
Fix - zinked bearings
Fixe - coussinets zingue

ART.	Confez. Box	Peso Kg Weight
4RG/CF	4	1,250

PIASTRA GIREVOLE SU SFERE

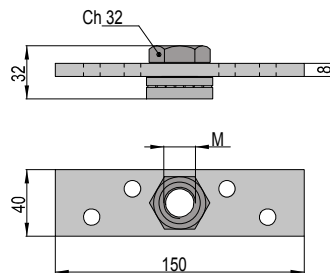

Rotating plate on thrust spheres.
Platine articulée sur billes.

ART.	M	Confez. Box	Peso Kg Weight
209S	20	20	0,460
209S/18	18	20	0,460

PIASTRA FISSA CON OLIVA GIREVOLE IN OTTONE

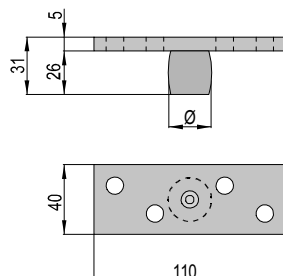
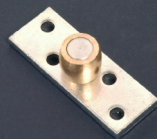

Fix plate with rotating olive in brass.
Platine fixe avec olive articulée en laiton.

ART.	Ø	Confez. Box	Peso Kg Weight
309/25	25	25	0,270
309/30	30	25	0,310



FERMO DI ARRESTO CON PARACOLPO IN GOMMA

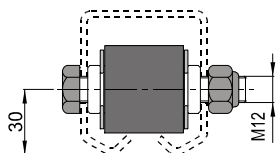

Back stop with rubber buffer.

Ferme d'arrêt avec butoir en gomme.

ART.	Confez. Box	Peso Kg Weight	
475	6	0,250	

BLOCCHETTO GUIDA

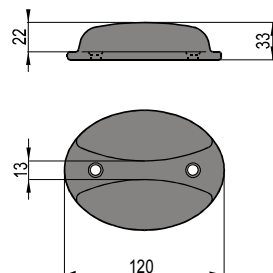

Meeting point.

Bloc guide.

ART.	Confez. Box	Peso Kg Weight	
BG/2000	12	1,370	

ATTACCO LATERALE A FASCIA REGISTRABILE

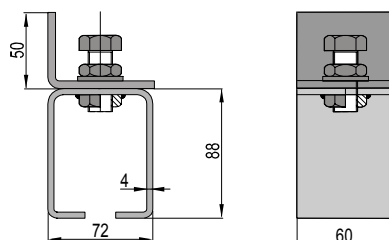

Lateral adjustable support.

Support lateral avec réglage.

ART.	Confez. Box	Peso Kg Weight	
ALG9	10	0,700	

ATTACCO A SOFFITTO A FASCIA REGISTRABILE

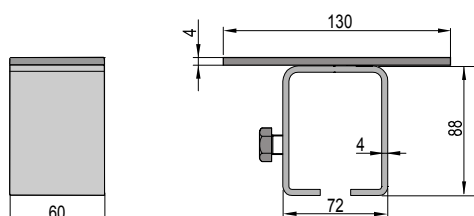

Adjustable support.

Support pour plafond avec réglage.

ART.	Confez. Box	Peso Kg Weight	
ASG9	10	0,750	

GUIDA INFERIORE IN ACCIAIO

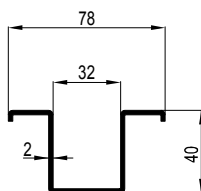

Lower guide in steel.

Guide inferieur en acier.

ART.	Confez. Box	Peso Kg Weight	
G8I	36 m n° 6x6 m	Kg/m 2,730	



PETTITI GIUSEPPE s.p.a.

SERIE FREJUS FRANCE

PORTATA	Per coppia di carrelli
CAPACITY	For each pair of trolleys
PORTEE	Pour couple de chariots
Kg 200	a 2 cuscinetti with 2 bearings
Kg 650	a 4 cuscinetti with 4 bearings

CARRELLI ED ACCESSORI PER MONOROTAIA G10ZF

TROLLEYS AND ACCESSORIES FOR RAIL G10ZF

CHARIOTS ET ACCESSOIRES POUR MONORAIL G10ZF

MONOROTAIA IN ACCIAIO ZINCATO

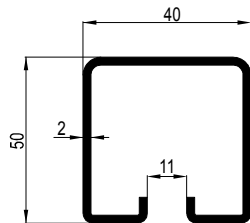
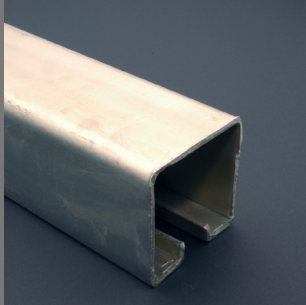

Rail in zinked steel.

Monorail en acier zingue.

ART.	Confez. Box	Peso Kg Weight
G10ZF	36 m n° 6x6 m	Kg/m 2,480

CARRELLO FISSO A 2 RUOTE

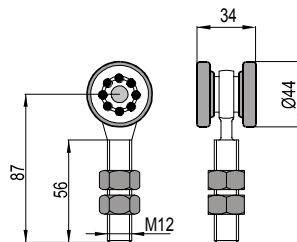

Fix trolley with 2 wheels.

Chariot fixe à 2 roulements.

2RP/CF	Fisso - cuscinetti zincati Fix - zinked bearings Fixe - coussinets zingue
---------------	---

ART.	Confez. Box	Peso Kg Weight
2RP/CF	20	0,280

CARRELLO FISSO A 4 RUOTE

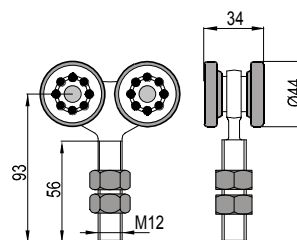

Fix trolley with 4 wheels .

Chariot fixe à 4 roulements.

4RP/CF	Fisso - cuscinetti zincati Fix - zinked bearings Fixe - coussinets zingue
---------------	---

ART.	Confez. Box	Peso Kg Weight
4RP/CF	10	0,540

PIASTRA GIREVOLE SU SFERE

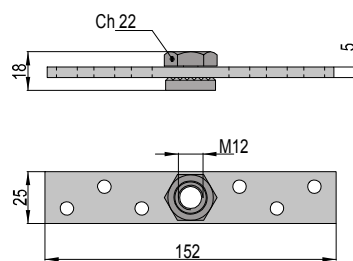
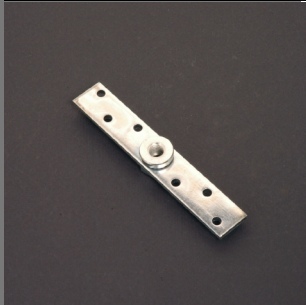

Rotating plate on balls.

Platine articulee sur billes.

ART.	Confez. Box	Peso Kg Weight
210S	50	0,170

PIASTRA FISSA CON OLIVA GIREVOLE IN OTTONE

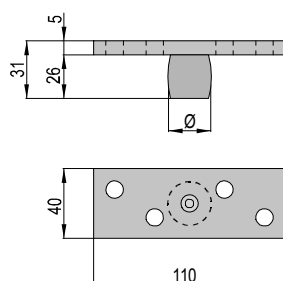
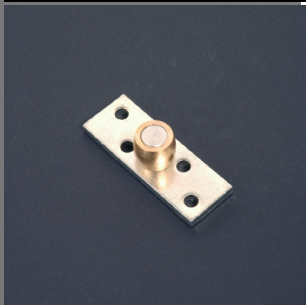

Fix plate with rotating olive in brass.

Platine fixe avec olive articulée en laiton.

ART.	Ø	Confez. Box	Peso Kg Weight
309/25	25	25	0,270
309/30	30	25	0,310



FERMO DI ARRESTO CON PARACOLPO IN GOMMA

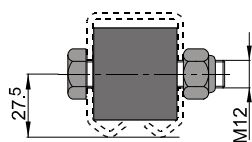

Back stop with rubber buffer.

Ferme d'arrêt avec butoir en gomme.

ART.	Confez. Box	Peso Kg Weight	
465	6	0,200	

BLOCCHETTO GUIDA

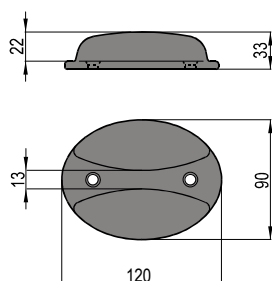

Meeting point.

Bloc guide.

ART.	Confez. Box	Peso Kg Weight	
BG/2000	12	1,370	

ATTACCO LATERALE A FASCIA REGISTRABILE

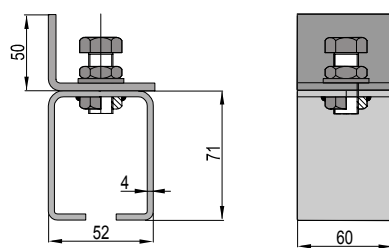

Adjustable lateral support.

Support pour latéral avec réglage.

ART.	Confez. Box	Peso Kg Weight	
ALG10	10	0,600	

ATTACCO A SOFFITTO A FASCIA REGISTRABILE

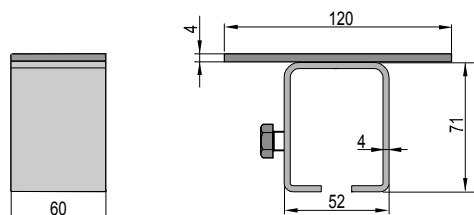

Adjustable support.

Support pour plafond avec réglage.

ART.	Confez. Box	Peso Kg Weight	
ASG10	10	0,650	

GUIDA INFERIORE IN ACCIAIO

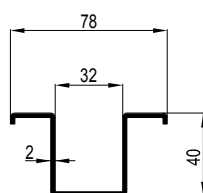

Lunghezza = 6 m
Length = 6 m
Longueur = 6 m

Lower guide in steel.

Guide inferieur en acier.

ART.	Confez. Box	Peso Kg Weight	
G8I	36 m n° 6x6 m	Kg/m 2,730	



PETTITI GIUSEPPE s.p.a.

SERIE MINILUCE FRANCE

PORTATA	Per coppia di carrelli
CAPACITY	For each pair of trolleys
PORTEE	Pour couple de chariots
Kg 60	a 2 cuscinetti
	with 2 bearings
Kg 85	a 2 coussinets
	with 4 bearings
	a 4 coussinets

CARRELLI ED ACCESSORI PER MONOROTAIA G12ZF

TROLLEYS AND ACCESSORIES FOR RAIL G12ZF

CHARIOTS ET ACCESSOIRES POUR MONORAIL G12ZF

MONOROTAIA IN ACCIAIO ZINCATO

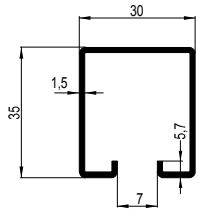

Rail in zinked steel.
Monorail en acier zingue.

ART.	Confez. Box	Peso Kg Weight
G12ZF	54 m n° 9x6 m	Kg/m 1,450

CARRELLO FISSO A 2 RUOTE

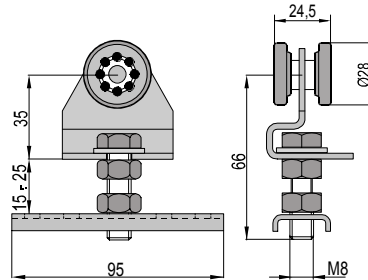
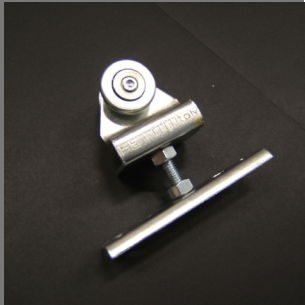

Fix trolley with 2 wheels.
Chariot fixe à 2 roulements.

2RMF	Fisso - cuscinetti in acciaio Fixed - steel bearings Fixe - coussinets en acier
-------------	---

ART.	Confez. Box	Peso Kg Weight
2RMF	60	0,185

CARRELLO FISSO A 4 RUOTE

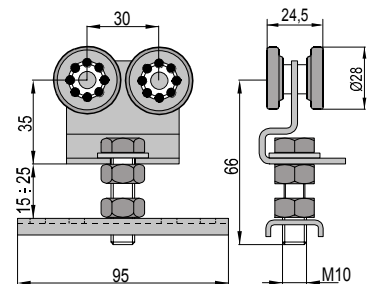

Fix trolley with 4 wheels .
Chariot fixe à 4 roulements.

4RMF	Fisso - cuscinetti in acciaio Fixed - steel bearings Fixe - coussinets en acier
-------------	---

ART.	Confez. Box	Peso Kg Weight
4RMF	30	0,280

FERMO DI ARRESTO CON PARACOLPI IN GOMMA

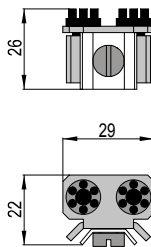

Back stop with rubber buffers.
Ferme d'arrêt avec butoir en gomme.

ART.	Confez. Box	Peso Kg Weight
412	100	0,020

PIASTRA FISSA CON OLIVA GIREVOLE CENTRALE

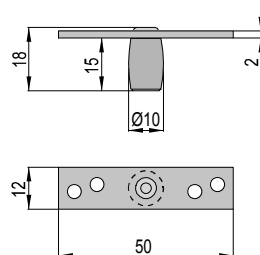

Fix plate with rotating olive.
Platine fixe avec olive articulée.

312B	Piastra in acciaio zincato, oliva in ottone. Plate in zinked steel, olive in brass. Platine en acier zingué, olive en laiton.
312BN/INOX	Piastra in acciaio inox, oliva in nylon. Plate in stainless steel, olive in nylon. Platine en acier inox, olive en nylon.

ART.	Confez. Box	Peso Kg Weight
312B	50	0,015
312BN/INOX	50	0,015

INOX - STAINLESS

PIASTRA FISSA CON OLIVA GIREVOLE LATERALE

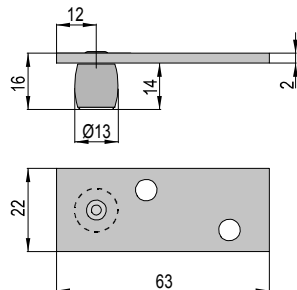

Fix plate with rotating side olive in brass.

Platine fixe avec olive articulée en laiton.

ART.	Confez. Box	Peso Kg Weight
312A	80	0,045

GUIDA INFERIORE IN NYLON

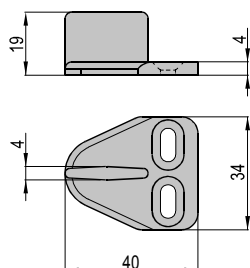

Lower guide in nylon.

Guide inférieure en nylon.

ART.	Confez. Box	Peso Kg Weight
312	60	0,006

GUIDA INFERIORE IN NYLON

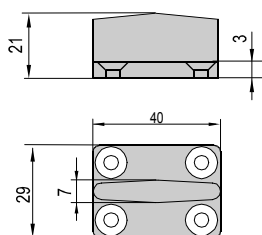
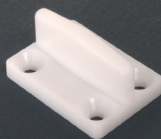

Lower guide in nylon.

Guide inférieure en nylon.

ART.	Confez. Box	Peso Kg Weight
312/A	60	0,006

ATTACCO LATERALE A FASCIA REGISTRABILE

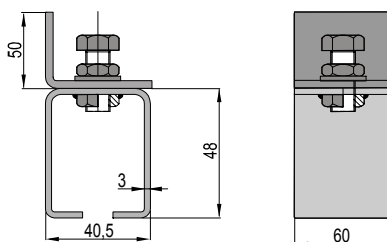

Lateral adjustable support.

Support lateral avec réglage.

ART.	Confez. Box	Peso Kg Weight
ALG12	10	0,400

ATTACCO A SOFFITTO A FASCIA REGISTRABILE

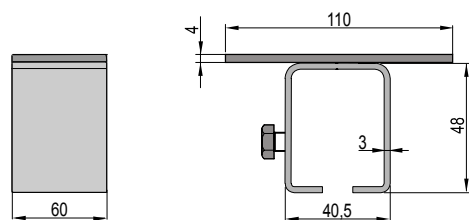

Adjustable support.

Support pour plafond avec réglage.

ART.	Confez. Box	Peso Kg Weight
ASG12	10	0,450

GUIDA INFERIORE IN ALLUMINIO GREZZO

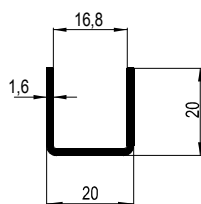
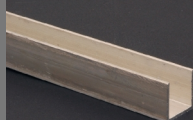

Lunghezza = 6 m

Length = 6 m

Longueur = 6 m

Lower guide in aluminium.

Guide inférieure en aluminium.

ART.	Confez. Box	Peso Kg Weight
GIM	72 m n° 12x6 m	Kg/m 0,235



L'applicazione è valida per la serie Miniluce France
 The application is valid for Miniluce France serie
 L'application est valide pour la série Miniluce France.

